



CHIR



CHIROPODY INSTRUMENTS



Blacks File

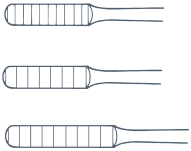

- 5001/00 fine
- 5001/01 medium
- 5001/02 tungsten carbide



Probe, Swan Neck

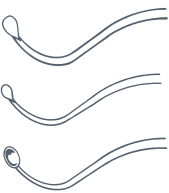

- 5002/01 flat, medium
- 5002/02 flat, small
- 5002/03 cupped



Beaver Blade Holder



- 5003/01 hexagonal
- 5003/02 round



Nail Chisel



- stainless steel
- 5005/01



CHIROPODY KNIVES



5004/03 fig 49

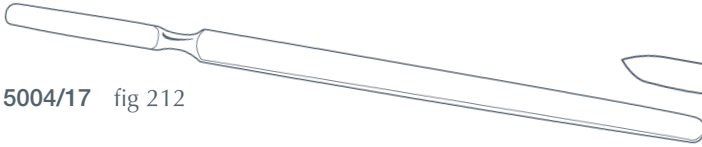

5004/17 fig 212

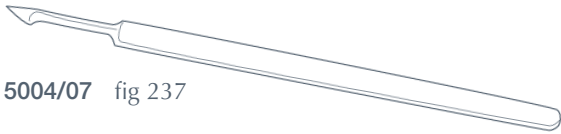

5004/07 fig 237

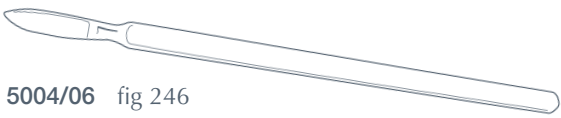

5004/06 fig 246

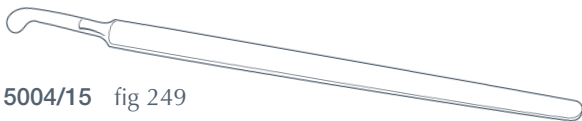

5004/15 fig 249

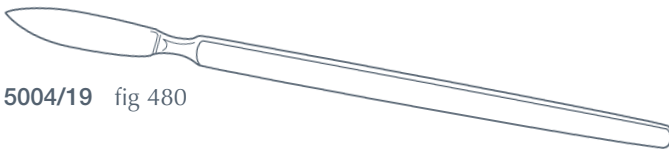

5004/19 fig 480

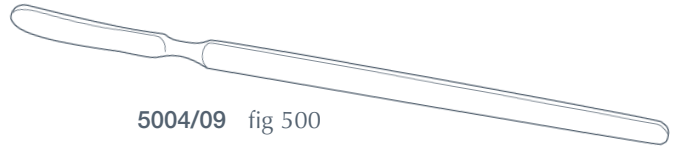

5004/09 fig 500



5004/18 fig 221

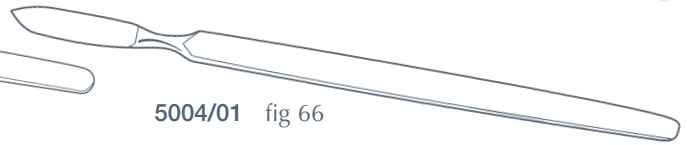

5004/01 fig 66

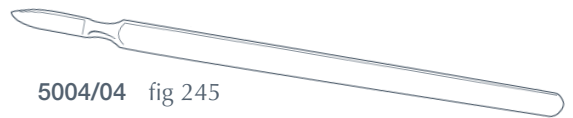

5004/04 fig 245

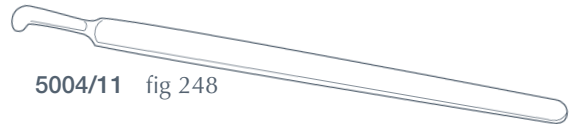

5004/11 fig 248

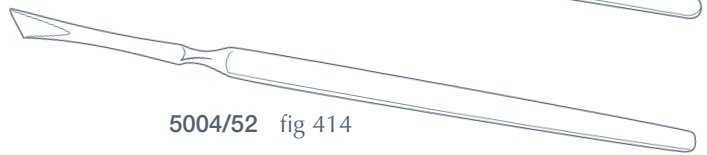

5004/52 fig 414

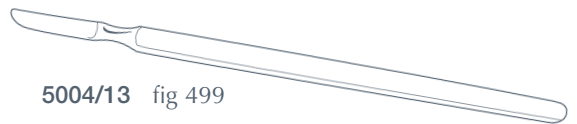

5004/13 fig 499

CHIR

NIPPERS

Concave

stainless steel with catch

5006/01 140mm



stainless steel without catch

5006/02 140mm

Flat

stainless steel with catch

5007/01 140mm



stainless steel without catch

5007/02 140mm

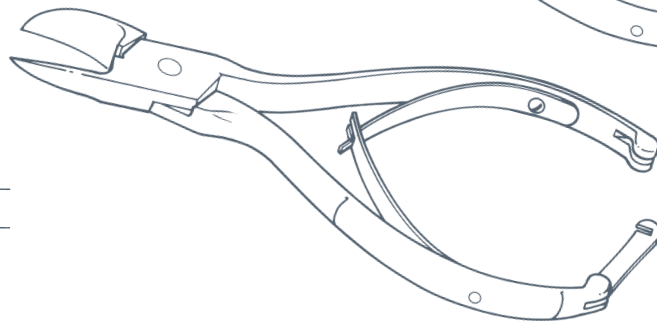
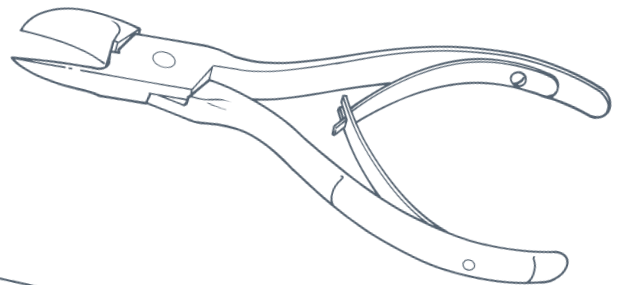



NIPPERS

Thwaites

for ingrowing nails
5008/01 130mm

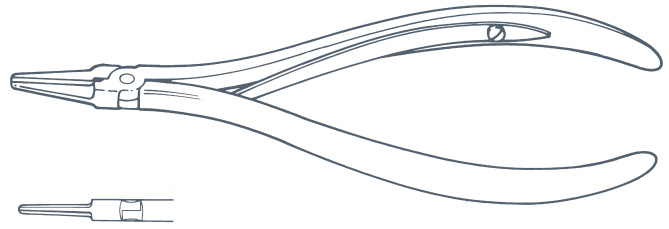

SURGICAL SCISSORS

Chiropody

short strong blades specifically designed
to cut felt with ease

straight, blunt/blunt
5042/20 150mm

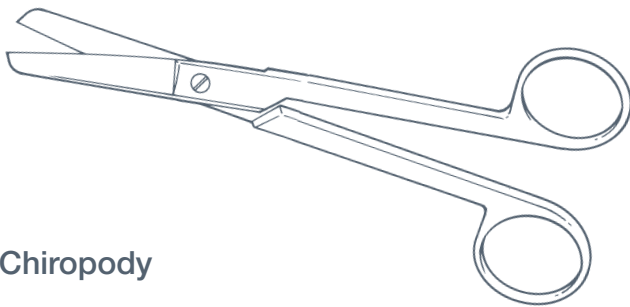

straight, blunt/sharp
5043/20 150mm

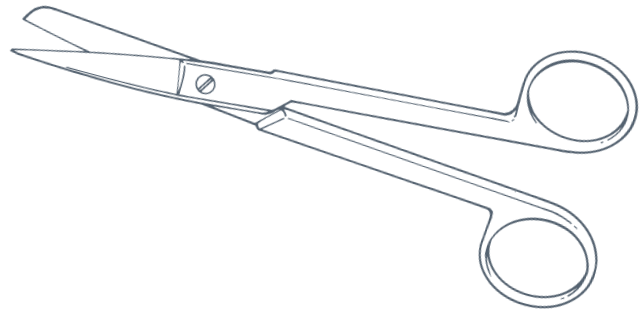

straight, sharp/sharp
5044/20 150mm

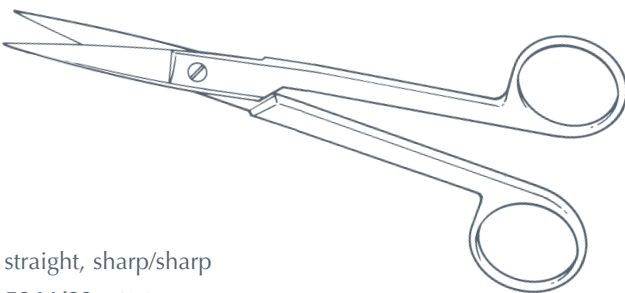

curved, blunt/blunt
5045/20 150mm

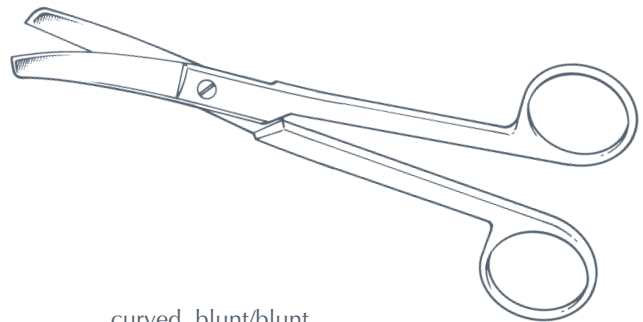

Chiropody

curved, blunt/sharp
5046/20 150mm

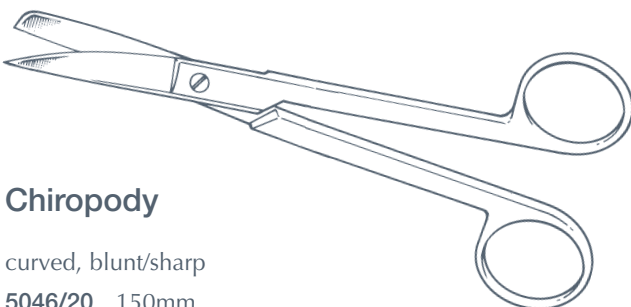

curved, sharp/sharp
5047/20 150mm

